

FI3 SK Series Creative Flat Panel Display Specification



KMTEKLED PHOTOELECTRICITY CO.LTD

Vision: Make the LED display more colorful, more intelligent, To be the leading brand in led screen industry.

Catalogue

Chapter 1 Product Introduction	2
Chapter 2 Structural Appearance	3
2.1 Module Pictures	3
2.2 Cabinet Pictures	3
2.3 Technical Parameters	4
2.4 Packing List	5
2.5 Power Supply Configuration Project	5
2.6 Accessories	5
Chapter 3 Interface Definition	6
3.1 Interface Picture (HUB75)	6
3.2 Interface Definition	6
Chapter 4 Installation	7
4.1 Cabinet Installation	7
4.2 Display Installation	7
4.3 Networking Introduction	8
4.4 Installation Scenarios	8
Chapter 5 Description for Product Features	9
5.1 Ultra Slim and Light Weight	9
5.2 Alternative Cabinet Size Options	9
Chapter 6 User Manual	10
6.1 Notification	10
6.2 User Manual	10
6.3 Acceptance Request and Method	11
Chapter 7 Application Field	12

Chapter 1 Product Introduction

- **Aluminium profile cabine structure**

With light weight, corrosion resistance, high precision, good flatness, not easy to deform, good heat dissipation, etc., stronger and more durable than the sheet metal cabine, aluminium profile structure through the finishing process, which can improve the screen splicing accuracy, screen consistency is better.

- **Ultra-light and ultra-thin**

The thickness of the whole cabine is 20mm, the weight is 4.8/3.6/2.4kg, which is easy to transport. The thickness of 20mm allows the panel to be attached to the wall or embedded in the wall, and blends in with the decorative style.

- **Quick Installation**

Module automatic adsorption, cabine quick-lock connection, can be installed against the wall without steel structure, support XYZ three-axis fine-tuning, installation is more convenient, saving manpower and material resources.

- **Full front maintenance design**

Magnetic front maintenance design, all components support front-end maintenance, the adapter plate supports tool-less disassembly and installation, saving time, convenient and quick.

- **Free splicing, more flexible installation**

1000*250mm/750*250mm/500*250mm various cabine sizes, cabine bevelling design (optional), easy to achieve 90 °, arc splicing, support for hanging, wall mounting, floor mounting a variety of installation modes, support for 90 ° rotating cabine installation.

- **stable and reliable**

Module hard connection, no cable design, support dual card backup, dual power backup (optional), 4 network port input and output, more stable transmission effect.

Chapter 2 Structural Appearance

2.1 Module Pictures

(FI3 SK Series)

Picture 2-1 modules(250*250mm)

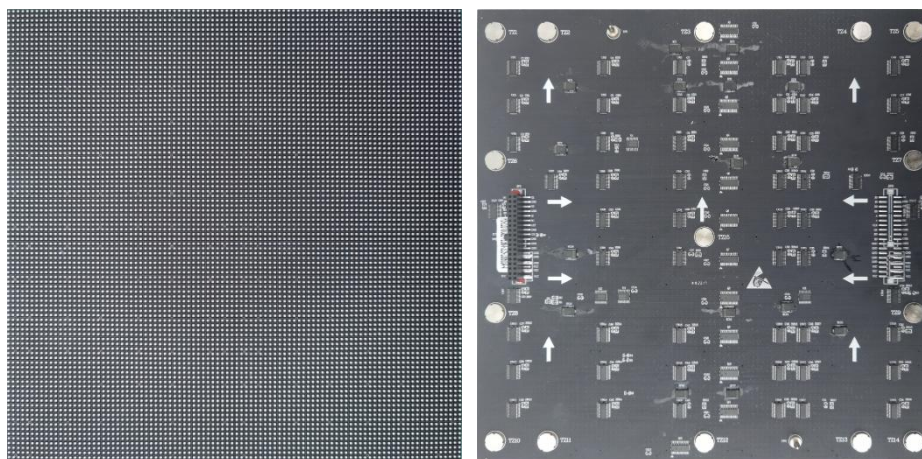

2.2 Cabinet Pictures

Picture 2-2 Aluminium profiles cabinet (1000*250*20mm)

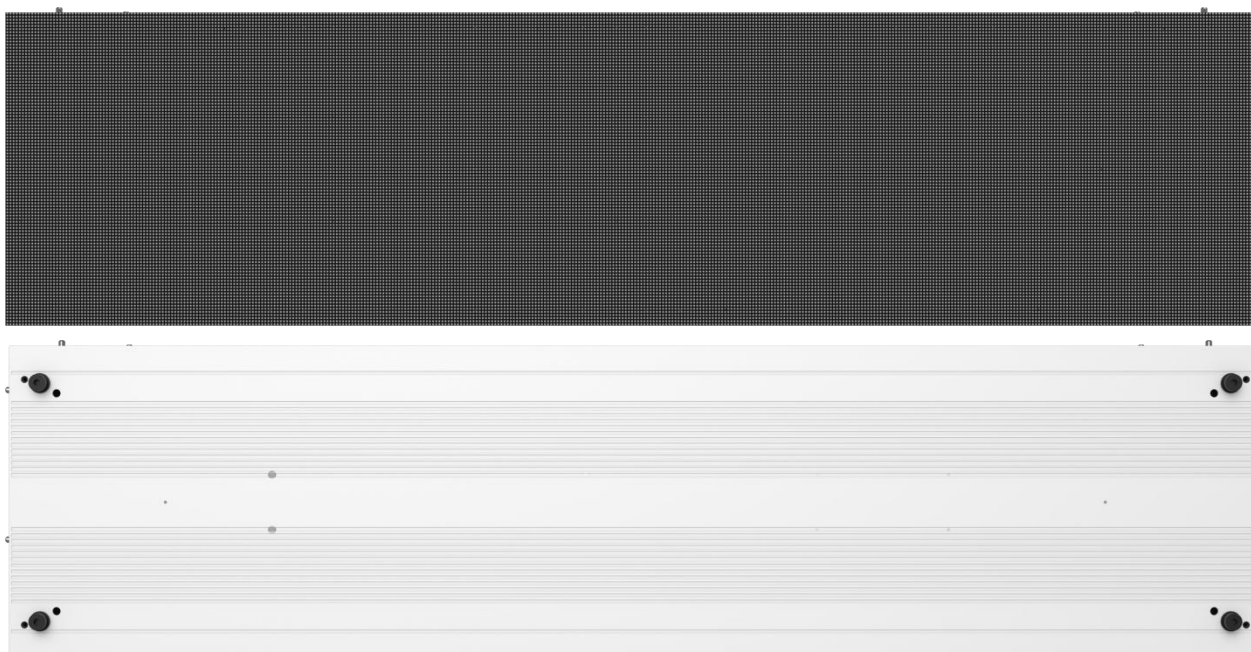

2.3 Technical Parameters

Table 2-1 Technical Parameters

Item	SK1.56	SK1.953	SK2.604	SK2.97	SK3.91
Pixel Composition(SMD)	1212	1515	1515	2020	2020
Pixel Pitch(mm)	1.56	1.953	2.604	2.97	3.91
Module Resolution(W×H)	160×160	128×128	96×96	84×84	64×64
Module Size(mm)	250×250				
Module Weight(kg)	0.5				
Module Qty/Cabinet(W×H)	2×4 / 2×3 / 2×2				
Cabinet Resolution(W×H)	640×160	512×128	384×96	336×84	256×64
Cabinet Size(mm)	1000×250×20 / 750×250×20 / 500×250×20				
Cabinet Area(m ²)	0.25				
Cabinet Weight(kg/cabinet)	4.8 / 3.6 / 2.4				
Cabinet Material	Aluminium profiles				
Cabinet Density (dot/m ²)	409600	262144	147456	112896	65536
IP Rating	IP20				
White Balance Brightness(nits)	≥600	≥600	≥600	≥600	≥600
Color Processor(bit)	14	14	16	16	16
Color Temperature(K)	6500-9000				
Visual Angle(H/V)	140°/ 120°				
Luminous point centre deviation	<3%				
Luminance uniformity	≥97%				
Chromaticity uniformity	Within ±0.003Cx, Cy				
Contrast Ratio	≥5000:1				
The Max Power Consumption(W/m ²)	500	500	500	500	500
Average Power Consumption(W/m ²)	165	165	165	165	165
Input Voltage	AC100~240V				
Frequency(Hz)	50&60				
IC Driving(s)	1/40	1/32	1/32	1/28	1/16
Refreshing Ratio(Hz)	3840				
Maintenance Method	Front				
Lifespan(hrs)	100,000				
Work Temperature/Humidity	-10℃-50℃/10%RH-98%RH (Non Condensing)				
Storage Temperature/Humidity	-20℃-60℃/10%RH-98%RH (Non Condensing)				

*Note: Maximum power consumption fluctuates by 10% depending on the batch of LED chips, and specifications are subject to change without notice.

2.4 Packing List

Table 2-2 Packing List

Packing List	Quantity	Unit
LED Display	1	Set
User Manual	1	pcs
Approved Certificate	1	pcs
Warranty Card	1	pcs
Construction Notification	1	pcs



2.5 Power Supply Configuration Project

Table 2-3 Supply Configuration Project

Power Supply	Configuration Project
300/400W Power Supply	Can load 4pcs modules

2.6 Accessories

Table 2-4 Accessories List

Accessories		
		
Power Supply	Single Cable	Screws, connecting sheet, Sleeve Piece

Chapter 3 Interface Definition

3.1 Interface Picture (HUB75)

Picture 3-1 Interface Picture (HUB75)

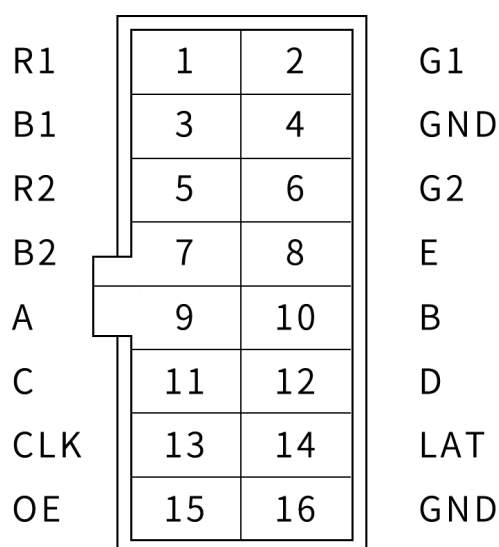

3.2 Interface Definition

Table 3-1 Interface Definition

Pin	Signal	Function	Pin	Signal	Function
1	R1	Red Data Signal	2	G1	Green Data Signal
3	B1	Blue Data Signal	4	GND	Power Ground
5	R2	Red Data Signal	6	G2	Green Data Signal
7	B2	Blue Data Signal	8	E	Row Decoding Signal
9	A	Row Decoding Signal	10	B	Row Decoding Signal
11	C	Row Decoding Signal	12	D	Row Decoding Signal
13	CLK	Clock Signal	14	LAT	Latch Signal
15	OE	Enable Signal	16	GND	Power Ground

Chapter 4 Installation

4.1 Cabinet Installation

Picture 4-1 Hole Installation Diagram for Kit

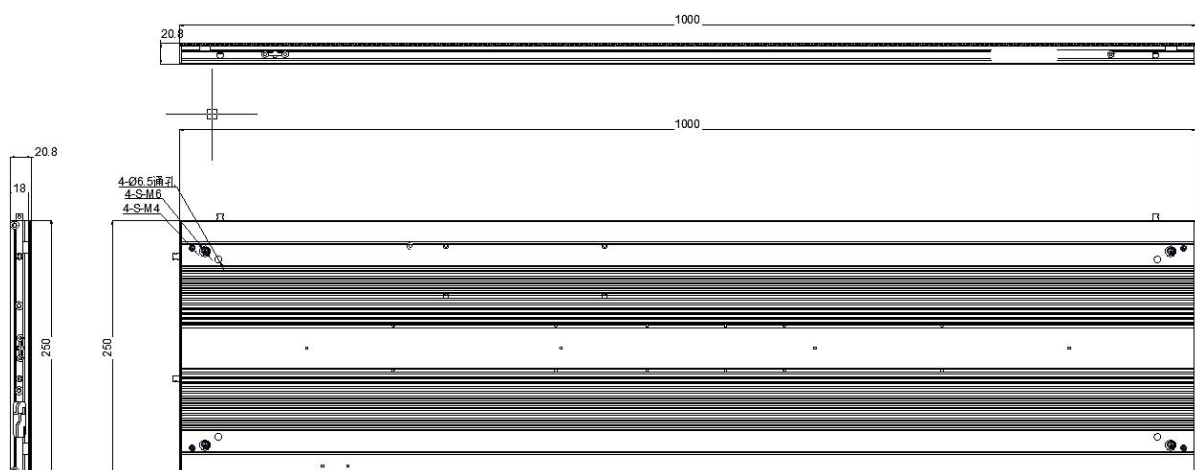

4.2 Display Installation

Picture 4-2 Diagram for Connection

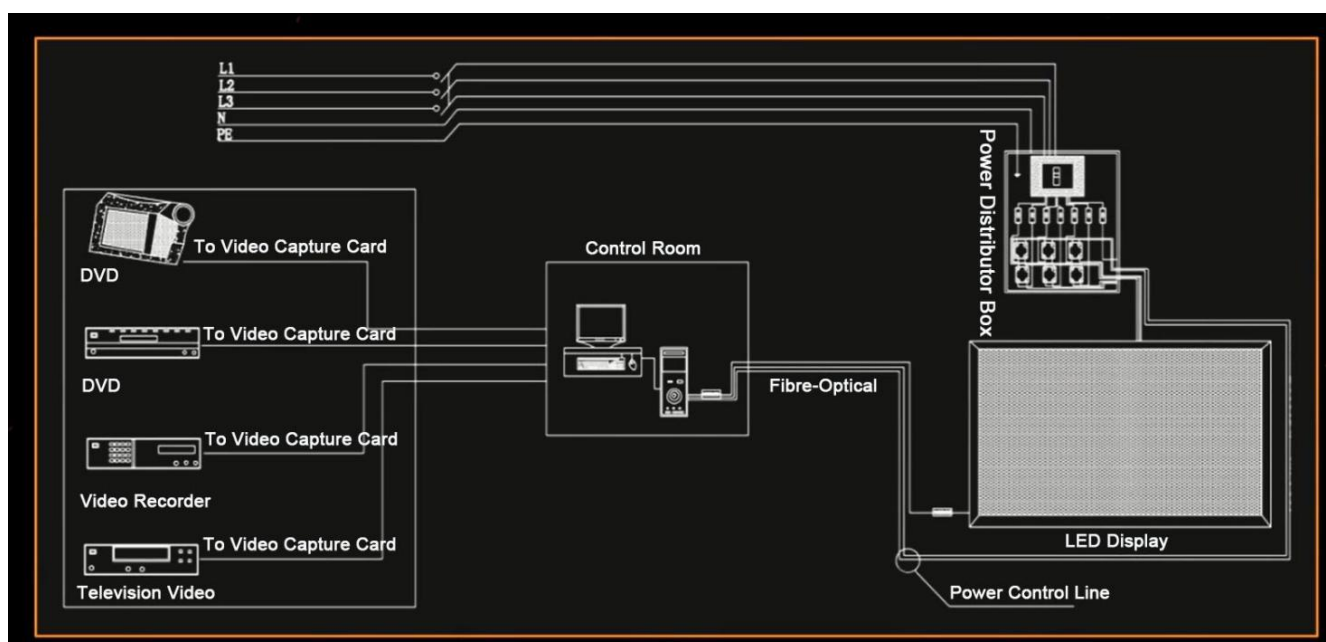

4.3 Networking Introduction

Picture 4-3 Topographic Picture for networking

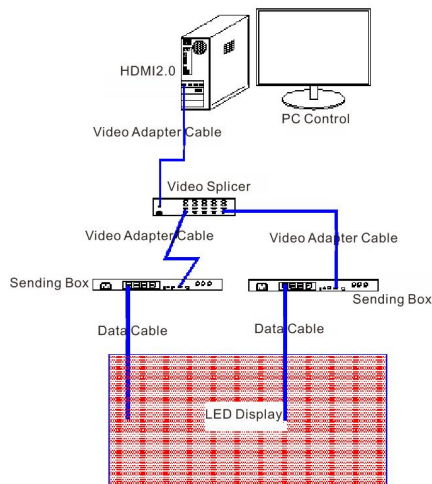

4.4 Installation Scenarios



Chapter 5 Description for Product Features

5.1 Ultra Slim and Light Weight

Weighing just 4.8kg per cabinet and at only 20mm thick.



5.2 Alternative Cabinet Size Options

1000*250mm, 750*250mm, 500*250mm cabinet could be easy to build any screen size for various project.



Chapter 6 User Manual

6.1 Notification

Table 6-1 Notification

Item	Notification
Temperature	Keep the work temperature within $-10^{\circ}\text{C} \sim 50^{\circ}\text{C}$
Humidity	Keep the storage temperature within $-20^{\circ}\text{C} \sim 60^{\circ}\text{C}$
Waterproof	Keep the work humidity within $10\%RH \sim 98\%RH$
Dust-proof	Keep the storage humidity within $10\%RH \sim 98\%RH$
Anti-Electromagnetic radiation	IP66
Electrostatic Prevention	IP66
Temperature	LED display shouldn't put under the environment where has strong interference by electromagnetic radiation, which would be easy to picture display abnormal.
Humidity	It should be ground connected well for power supply, cabinet, mental cover of display body, the resistance of ground connection $< 10\Omega$, to avoid making any damage to electric components.

6.2 User Manual

Table 6-2 User Manual

Item	User Manual
Electrostatic Protection	The installer need wear electrostatic ring and electric gloves, each equipment should take ground connection well when installing.
Connection Type	There are positive and negative electrode silk printed on module, don't allow to reverse connect, and prohibit to connect with AC 220V.
Operate Type	Prohibit to assemble module, cabinet and whole of display under power on, operation should be under power off completely, to protect personal safety; Prohibit anyone to touch when the LED display is working, in case the static electricity which is generated by body to break through LED and other components.
Dismantle and Transportation	Don't allow to throw, push, compress module, to prevent module falling down, to avoid breaking kit, damage LED chips, etc.
Environmental Inspection	It should match temperature and humidity meter for LED display at installation site, to monitor its surrounding environment, so that it can find out if LED display being affected with damp, moisture, etc.

Item	User Manual
The Usage of LED display	1.The environmental humidity should be 10%RH~65%RH, it is suggested to turn on LED display one time each day, normal to use above 4 hours each time, to remove its damp.
	2.When the environmental humidity is above 65%RH, it should make dehumidification to environment, and it is suggested to work LED display above 8h each day.
	3.When LED display has not turned on for a long time, it should preheat LED display to remove moisture before use, to avoid damage LED because of damp, the specific method: 20% brightness to work for 2h, 40% brightness to work for 2h, 60% brightness to work for 2h, 80% brightness to work for 2h, 100% brightness to work for 2h, by this to gradually increase its brightness.

6.3 Acceptance Request and Method

Table 6-3 Acceptance Request and Method for LED display

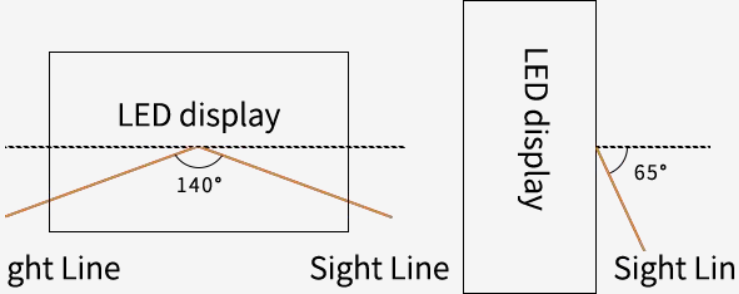
Item	Acceptance Request and Method
Brightness of LED Display	Switch LED display to work as full brightness, use light-gun to measure the brightness of LED display within 10 minutes. When measuring its brightness, the light-gun need be vertical to LED display, to adjust the distance of light-gun and LED display, ensure the view window, black area, cover above 16 pixels, adjust focal length, to ensure LED chip being able to clearly view in eyepiece, then measure and record brightness data.
Visual Angle	<p>The one should stand on the angle of 140°, bottom angle 65°to LED display when making measurement, it is requested that LED display should not have obvious the problem of dark block.</p> 

Chapter 7 Application Field

It can be used in retail malls, hotels, transport hubs, commercial properties, conference rooms, exhibition displays, theme parks and other areas.



Shopping mall window screens

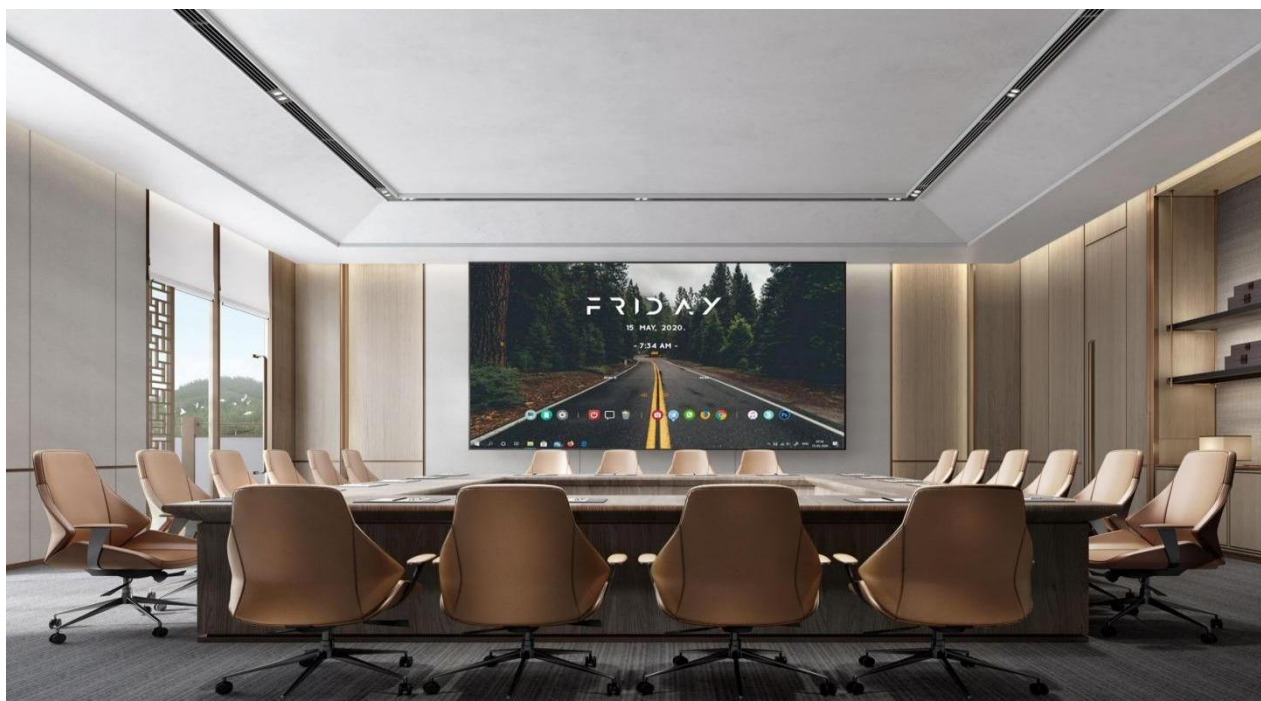

Meeting Room Smart Screen

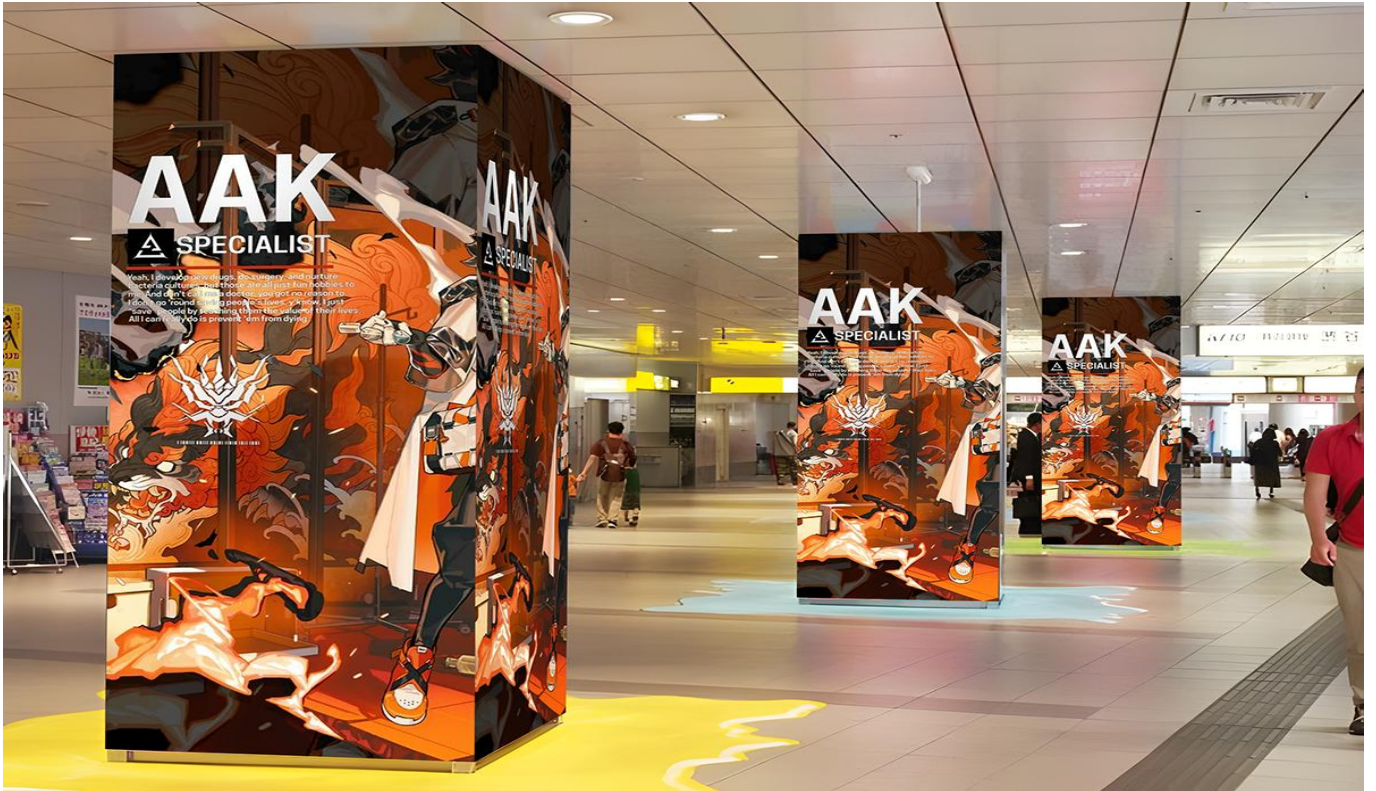

rectangular screen



canopy screen